



SD 80/2



SD 400/3 T

Pompe centrifughe monogiranti da scorrimento a media e alta portata caratterizzate da bocche di mandata da 2", 3" e 4"; trovano primaria applicazione nel campo dell'agricoltura e in tutte le applicazioni in cui una consistente portata è richiesta.

Single impeller centrifugal pumps, medium sliding high delivery with 2", 3" and 4" delivery openings; mainly used in agriculture and applications requiring high level delivery.

Bombas centrífugas con un rodete de desplazamiento de caudal medio y alto caracterizadas por bocas de salida de 2", 3" y 4"; encuentran aplicación primaria en el campo de la agricultura y en todas las aplicaciones en las que se solicita un caudal consistente.

Pompes de circulation centrifuges monoroue à débit moyen et élevé, caractérisées par des brides de refoulement de 2", 3" et 4"; elles trouvent leur application principale en agriculture et dans toutes les applications qui nécessitent un débit élevé.

**CARATTERISTICHE COSTRUTTIVE / CONSTRUCTION FEATURES  
CARACTERÍSTICAS CONSTRUCTIVAS / CARACTÉRISTIQUES D'EXÉCUTION**

<b>Corpo pompa</b>	ghisa
<b>Pump body</b>	cast iron
<b>Cuerpo bomba</b>	fundición
<b>Corps de pompe</b>	fonte
<b>Supporto motore</b>	ghisa
<b>Motor bracket</b>	cast iron
<b>Soporte motor</b>	fundición
<b>Support moteur</b>	fonte
<b>Girante</b>	ghisa / ottone (SDB)
<b>Impeller</b>	cast iron / brass (SDB)
<b>Rodete</b>	fundición / latón (SDB)
<b>Turbine</b>	fonte / laiton (SDB)
<b>Tenuta meccanica</b>	ceramica-grafite
<b>Mechanical seal</b>	ceramic-graphite
<b>Sello mecánico</b>	cerámica-grafito
<b>Garniture mécanique</b>	céramique-graphite
<b>Albero motore</b>	acciaio AISI 303 acciaio AISI 416 (SD 80-100)
<b>Motor shaft</b>	stainless steel AISI 303 stainless steel AISI 416 (SD 80-100)
<b>Eje motor</b>	acero AISI 303 acero AISI 416 (SD 80-100)
<b>Arbre moteur</b>	acier AISI 303 acier AISI 416 (SD 80-100)
<b>Temperatura del liquido</b>	
<b>Liquid temperature</b>	0 - 90 °C
<b>Temperatura del liquido</b>	
<b>Température du liquide</b>	
<b>Pressione di esercizio</b>	
<b>Operating pressure</b>	max 6 bar
<b>Presión de trabajo</b>	
<b>Pression de fonctionnement</b>	
<b>MOTORE / MOTOR / MOTOR / MOTEUR</b>	
<b>Motore 2 poli a induzione</b>	3~ 230/400V-50Hz
<b>2 pole induction motor</b>	1~ 230V-50Hz
<b>Motor de 2 polos a inducción</b>	con termoprotettore with thermal protection
<b>Moteur à induction à 2 pôles</b>	con protezione térmica avec protection thermique
<b>Classe di isolamento</b>	
<b>Insulation class</b>	F
<b>Clase de aislamiento</b>	
<b>Classe d'isolation</b>	
<b>Grado di protezione</b>	
<b>Protection degree</b>	IP44
<b>Grado de protección</b>	
<b>Protection</b>	

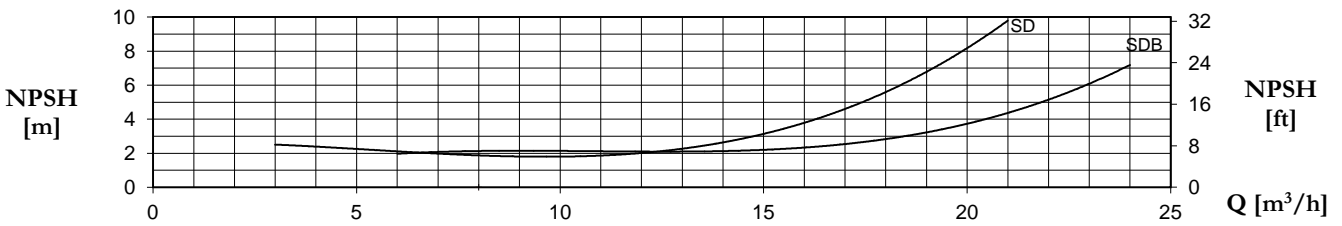
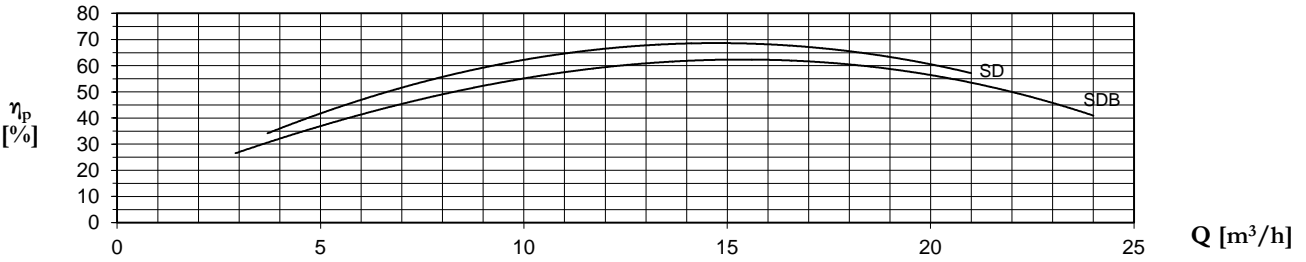
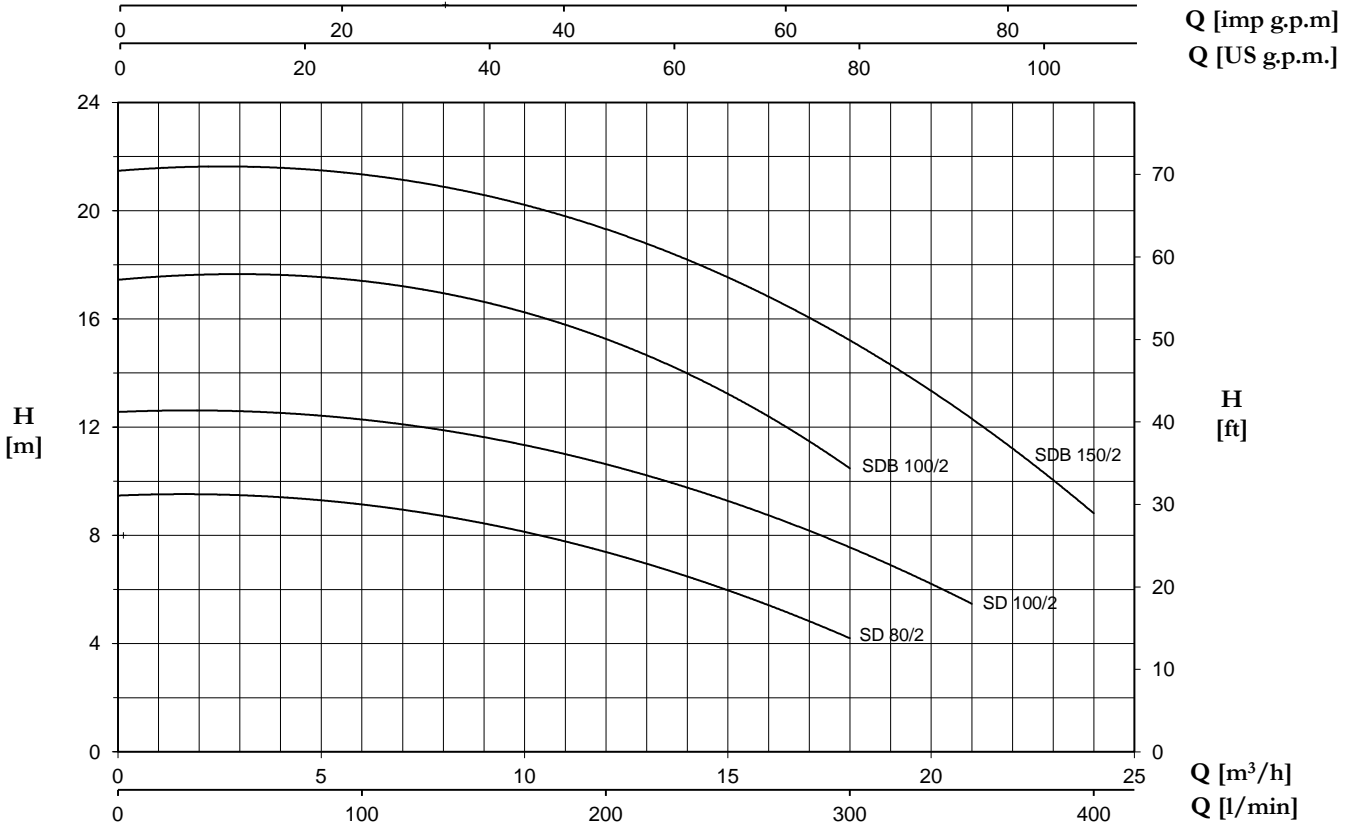

TYPE		P2		P1 (kW)		AMPERE		Q (m³/h - l/min)								
1~	3~					1~	3~	0	3	6	9	12	15	18	21	24
		(HP)	(kW)	1~	3~	1x230 V 50 Hz	3x400 V 50 Hz	0	50	100	150	200	250	300	350	400
		H (m)														
SD 80/2	SD 80/2 T	0,8	0,59	0,63	0,7	2,9	1,3	9,5	9,4	9,2	8,5	7,3	6	4,2	-	-
SD 100/2	SD 100/2 T	1	0,74	0,92	1,05	4,3	2,3	12,6	12,5	12,3	11,7	10,6	9,3	7,5	5,5	-
SDB 100/2	-	1	0,74	1,23	-	6	-	17,5	17,5	17,5	16,7	15,2	13,2	10,5	-	-
SDB 150/2	SDB 150/2 T	1,5	1,1	1,78	1,65	8,5	3	21,5	21,5	21,5	20,6	19,2	17,5	15,3	12,3	8,8

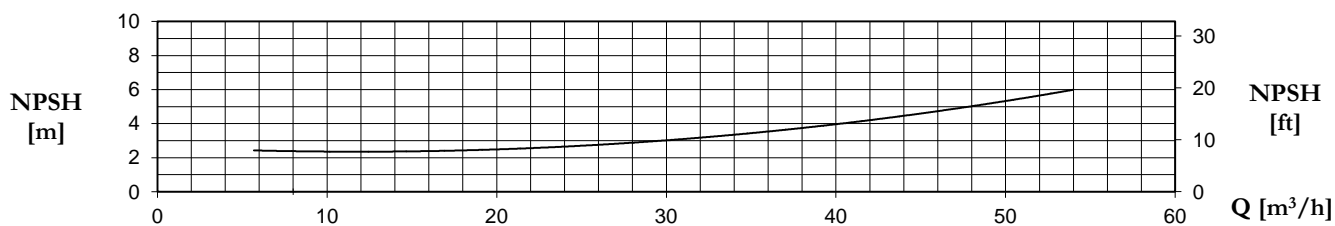
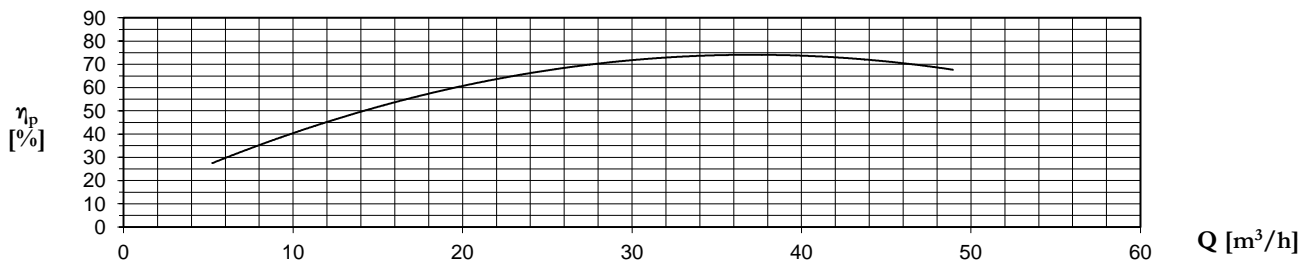
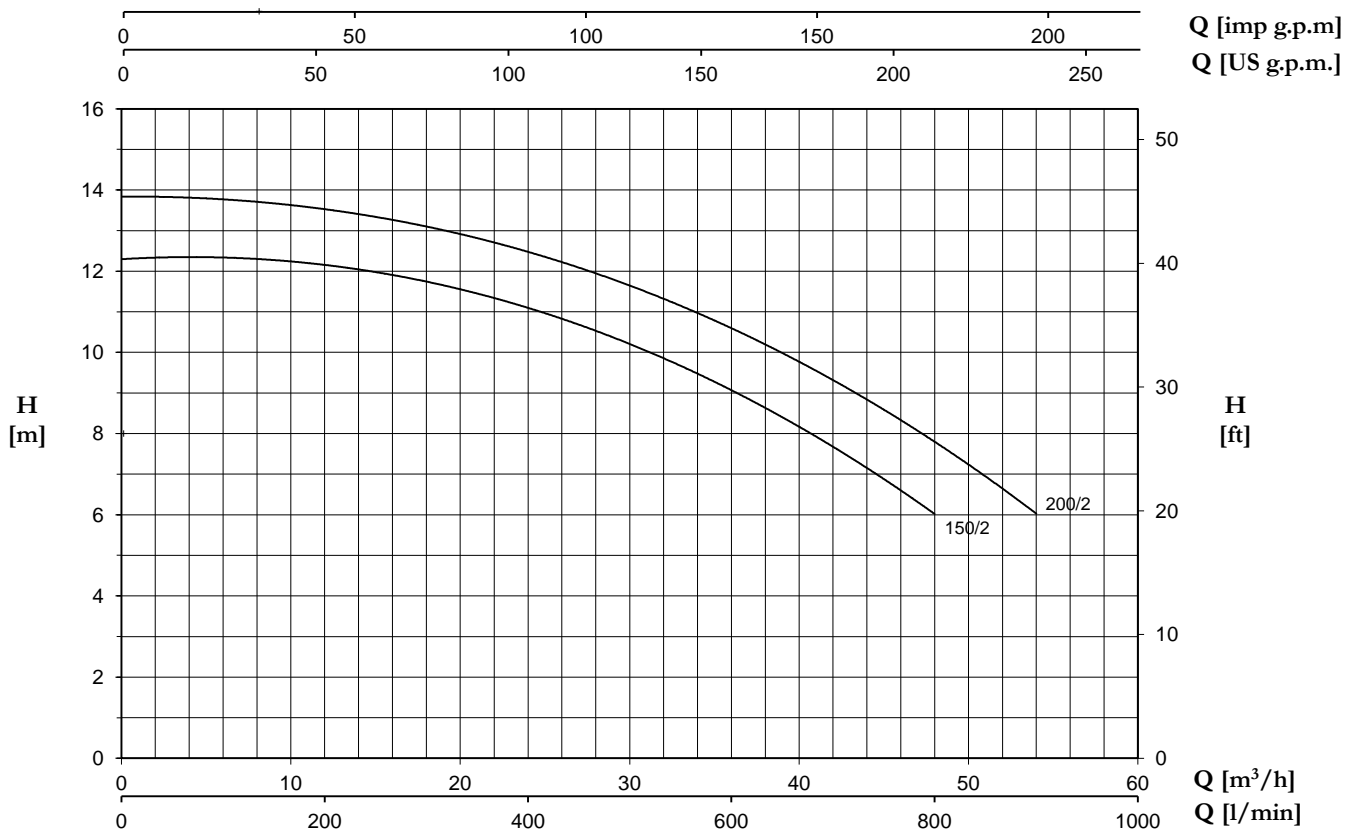

TYPE		P2		P1 (kW)		AMPERE		Q (m³/h - l/min)									
1~	3~	(HP)	(kW)	1~	3~	1~	3~	0	6	12	18	24	30	36	42	48	54
								0	100	200	300	400	500	600	700	800	900
								H (m)									
						1x230 V 50 Hz	3x400 V 50 Hz										
SD 150/2	SD 150/2 T	1,5	1,1	1,85	1,8	8,8	3,3	12,3	12,3	12,2	11,8	11,0	10,2	9,1	7,7	6	-
SD 200/2	SD 200/2 T	2	1,5	2,1	2,1	10	3,9	13,8	13,8	13,6	13,1	12,4	11,6	10,6	9,4	7,8	6

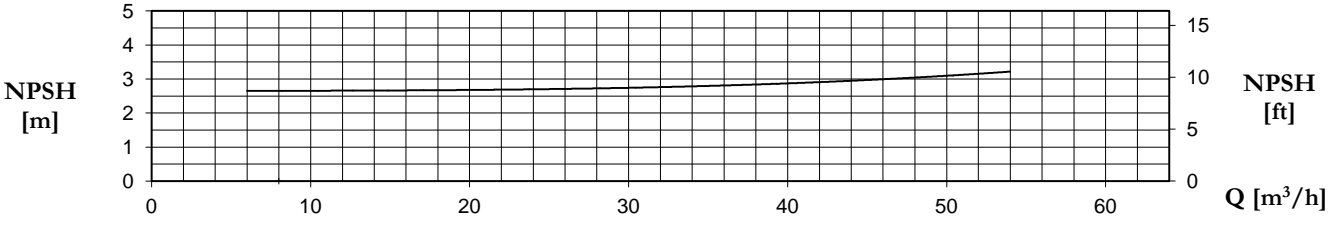
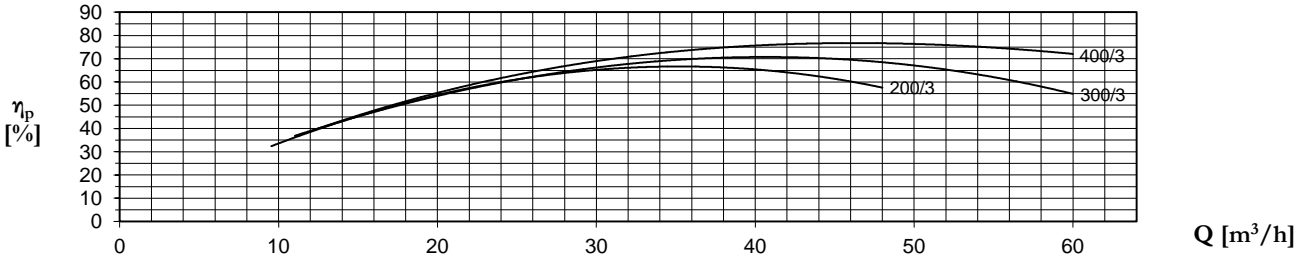
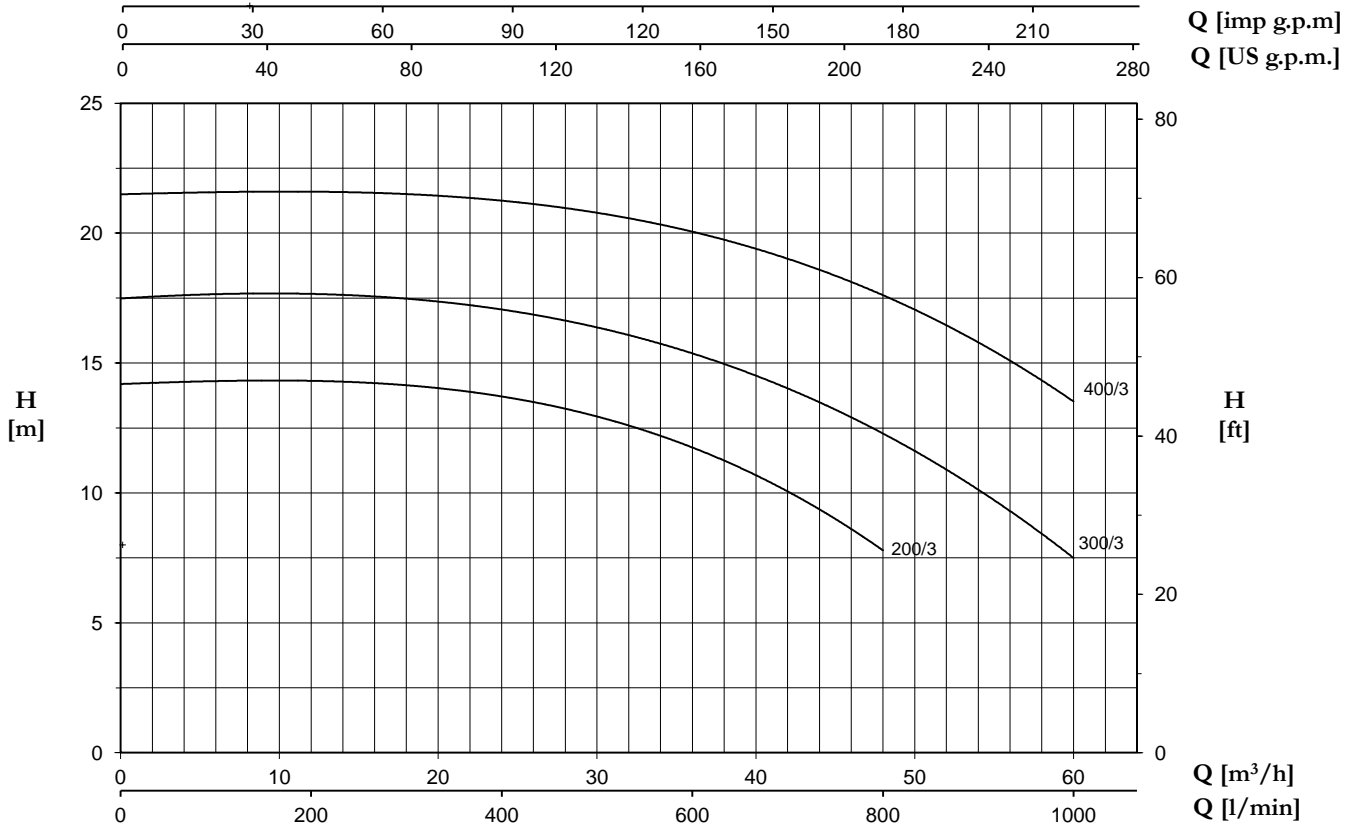

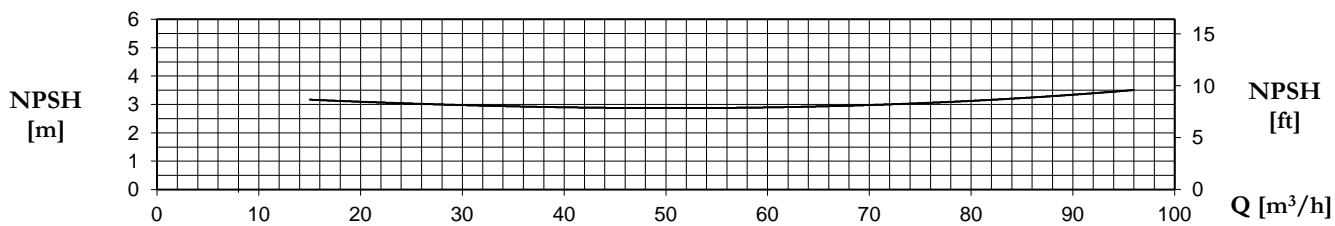
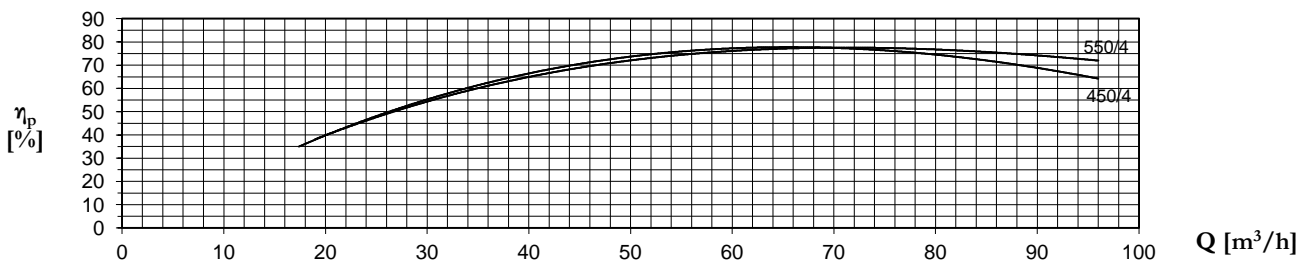
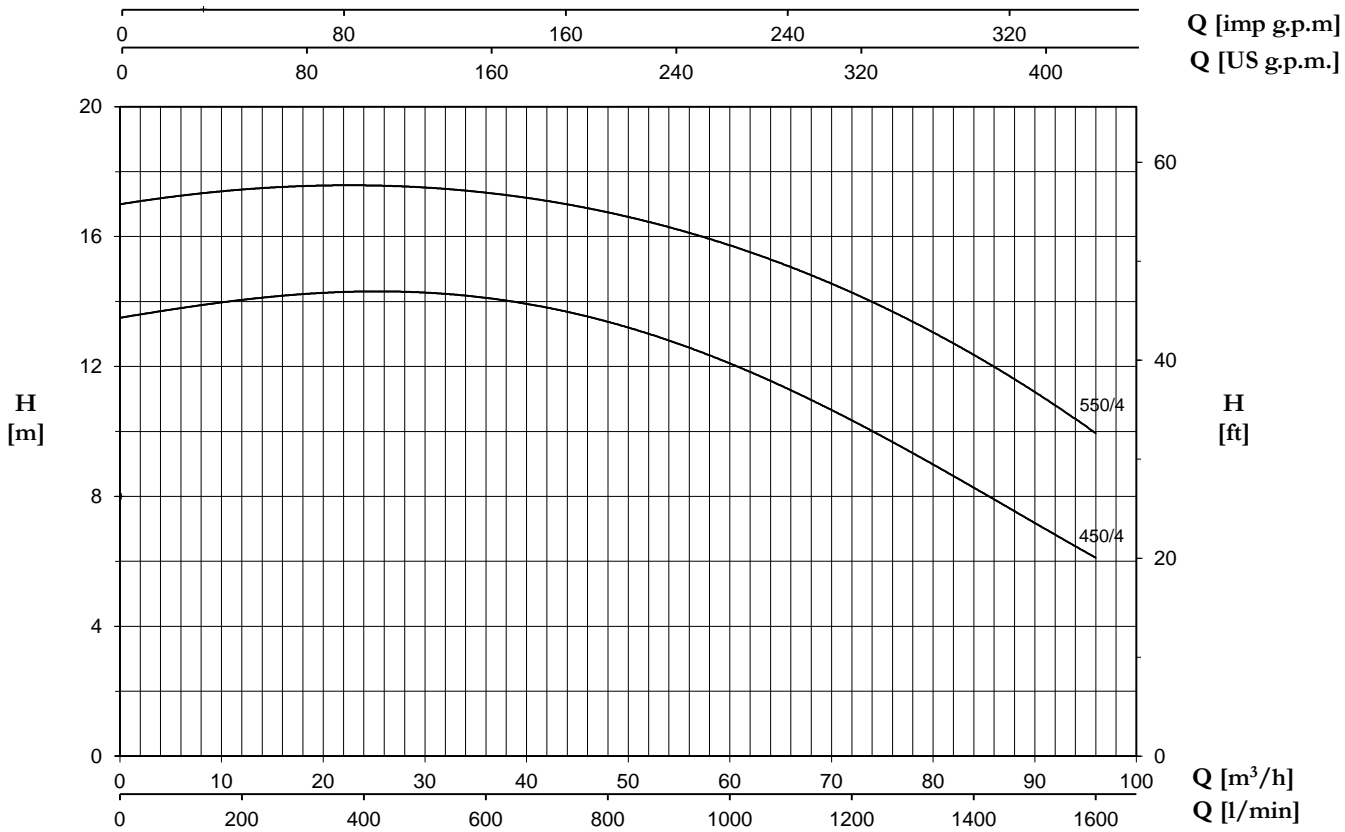

TYPE		P2		P1 (kW)		AMPERE		Q (m³/h - l/min)					
1~	3~	(HP)	(kW)	1~	3~	1~	3~	0	15	24	36	48	60
								0	250	400	600	800	1000
								H (m)					
						1x230 V 50 Hz	3x400 V 50 Hz						
SD 200/3	SD 200/3 T	2	1,5	2,35	2,15	11	3,6	14,2	14,2	13,8	11,7	7,8	-
SD 300/3	SD 300/3 T	3	2,2	3,3	2,9	15	4,9	17,5	17,5	17,2	15,3	12,3	7,5
-	SD 400/3 T	4	3	-	4	-	6,7	21,5	21,5	21,4	19,9	17,7	13,5

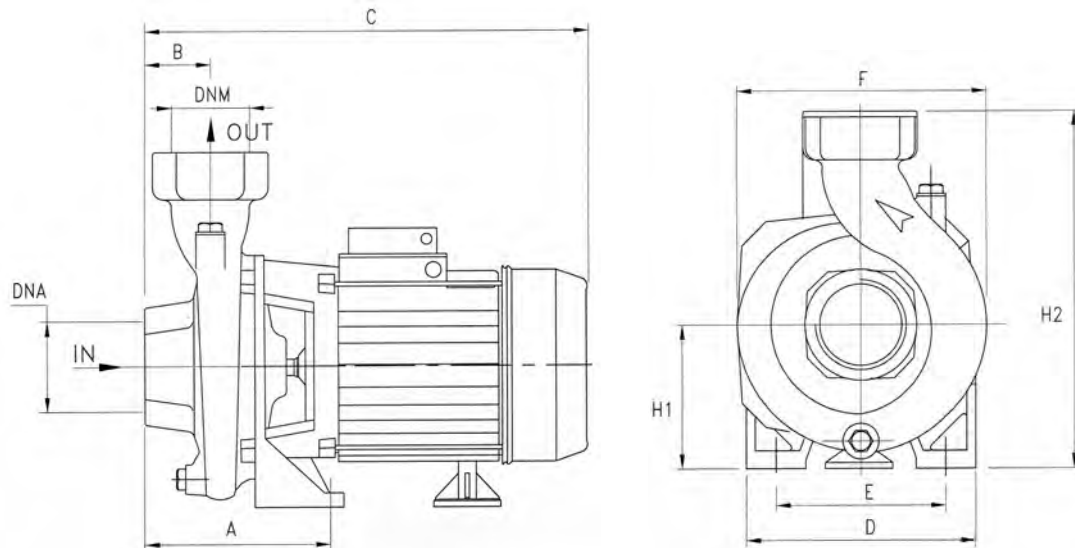

TYPE		P2		P1 (kW)		AMPERE		Q (m <sup>3</sup> /h - l/min)						
1~	3~	(HP)	(kW)	1~	3~	1~	3~	0	36	48	60	72	84	96
								0	600	800	1000	1200	1400	1600
						1x230 V 50 Hz		3x400 V 50 Hz		H (m)				
SD 450/4	SD 450/4 T	4	3	3,7	3,6	18	6,2	13,5	14,1	13,4	12,1	10,3	8,3	6,1
-	SD 550/4 T	5,5	4	-	5,05	-	8,8	17	17,3	16,8	15,7	14,4	12,2	10,0



TYPE	DIMENSIONS (mm)													 Kg
	A	B	C	D	E	F	H1	H2	DNA	DNM	I	L	M	
SD 80/2	127	45	315	155	115	178	97	247	2" G	2" G	340	195	280	14.2
SD 100/2	127	45	315	155	115	178	97	247	2" G	2" G	340	195	280	15.5
SD 150/2	150	53	370	180	140	218	115	285	2" G	2" G	390	230	325	23.3
SD 200/2	150	53	370	180	140	218	115	285	2" G	2" G	390	230	325	24.3
SDB 100/2	130	70	365	180	130	195	90	240	2" G	2" G	390	230	325	18.2
SDB 150/2	130	70	365	180	130	195	90	240	2" G	2" G	390	230	325	19.1
SD 200/3	176,5	80	455	200	140	225	112	292	3" G	3" G	480	245	330	28.3
SD 300/3	176,5	80	455	200	140	225	112	292	3" G	3" G	480	245	330	31.5
SD 400/3 T	176,5	80	455	200	140	225	112	292	3" G	3" G	480	245	330	31.6
SD 450/4 T	165	85	480	220	160	250	130	330	4" G	4" G	510	275	365	41.1
SD 550/4 T	165	85	480	220	160	250	130	330	4" G	4" G	510	275	365	41.1

TYPE				
	TRUCK		CONTAINER	
	PALLET (cm)	N° pumps	PALLET (cm)	N° pumps
SD 80/2-100/2	90x110x145	65	90x110x195	91
SD 150/2-200/2	85x110x140	40	85x110x205	60
SD 200/3-300/3	85x110x150	30	85x110x180	60
SD 450/4-550/4	80x120x150	30	80x120x180	60